

DAUS - 861

DAUS - 8 COLOURS LED 150W



- **Type:** Asymmetric washlight
- **Source:** 8 colours LED 150W
- **Optics:** Asymmetric

Asymmetric

The perfect LED alternative to traditional washlights!

Sharing the same qualities of control, colour mixing, coverage and silent operation as Dalis Cyclight, Dalis 861 is the perfect wash complement to the Dalis range. Configured into a rectangular format with 24 asymmetrical micro-reflectors and 8 LED emitters (6 colours plus a warm and a cool white) arranged in four rows, Dalis washlight gives access to a wide variety of saturated colours and pastel tones. Offering a very wide opening and a perfect even coverage, it is an ideal solution for side lighting, low-level light for dance, and as a short-form cyclorama luminaire when space is at premium.

Features

- **8-colour mixing LED system:** red, Green, Blue, Royal Blue, Amber, Cyan, Warm White (2200K), Cool White (6500K)
- **Very wide colour gamut:** the choice of the eight colours in association with the 16-bit control, results in an almost infinite range of repeatable colour possibilities
- **Impressive range of pastel tones:** desaturation of the colours possible with the addition of the Warm White and Cool White LEDs - no need to dim the light output
- **True tunable white:** from 2200K to 6500K - full spectrum to light backdrop
- **16-bit control of each colour:** precision dimming on every colour
- **Linear dimming curve:** no colour fading during dimming
- **Adjustable response time:** choice of fast or slow dimming for tungsten-like simulation - adjustment by DMX protocol
- **Strobe:** independent control of speed and duration
- **Easy control mode available:** preset calibrated colours with control of intensity and CCT
- **Ethernet-DMX node:** data IN through RJ45 connector; data OUT through DMX for daisy chaining
- **Universal data control:** compatible with DMX, RDM, Art-Net, sACN protocols
- **Remote setup:** all parameters can be adjusted by RDM protocol
- **Angular sensor:** tilt angle displayed for perfect alignment of all the units
- **Dimming parameters:** choice of square or linear dimming curves
- **Tilt reference on hanging yoke:** index for rapid re-positioning

Optical

- **Exclusive patented optical system:** 24 micro optical asymmetric reflectors delivering superbly smooth coverage across any surface
- **High efficiency:** massive light output, small power consumption
- **Long life:** outstanding operational lifetime expectation, no need to replace lamps, low maintenance
- **Perfect white:** the combination of the 2 whites with the 6 colours enables to produce white variations with very high quality (CRI >97) and high brightness
- **High transmissive coated protective glass window:** ensures optimal light transmission
- **Electronic dimmer:** dimming without clipping or cut-out at low intensity levels; high quality smoothing

Construction

- **Made in Europe:** control over all aspects of quality
- **PSU:** built-in electronic flicker-free power supply for easy, plug-and-play installation
- **Power connectors:** neutriK® powerCON TRUE1 TOP IN and OUT connectors for daisy chaining; delayed power out switching against inrush current
- **Fanless system:** convection cooling- perfect for sound sensitive applications - less maintenance required
- **Electronic thermal management system:** ensures maximum performance of the system without any risk of overheating

Picture:861

DSEN287_861 - 07/08/2020

Robert Juliat reserves the right to change or alter any of the items detailed on this page, to increase or improve manufacturing techniques without prior notice.

Robert Juliat S.A.S., 32 rue de Beaumont, 60530 Fresnoy-en-Thelle - France
Telephone : +33 (0)3 44 26 51 89 - fax : +33 (0)3 44 26 90 79 - info@robertjuliat.fr
www.robertjuliat.com



ROBERT JULIAT

Source (Light quality report(s) available at the end of the document)

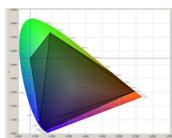

- **Lamp type:** LED - 8 colours
- **Power:** 138 W
- **Lumen output:** 10239 lm
- **Life:** 40000 hours (LM70)

| Colours | Power * | Lumen output* | Colour temperature* | CRI* (min) |
|------------|---------|---------------|---------------------|------------|
| Red | 9 W | 694 lm | | |
| Green | 13 W | 1 000 lm | | |
| Blue | 13 W | 350 lm | | |
| Royal blue | 13 W | 1 923 lm | | |
| Cyan | 12 W | 448 lm | | |
| Amber | 13 W | 592 lm | | |
| Warm white | 33 W | 1 992 lm | 2200K | 80 |
| Cool white | 33 W | 3 240 lm | 6500K | 70 |

(*) manufacturer's data

Optics

Characteristics

- **Type:** Asymmetric
- **Horizontal spread:** °
- **Vertical spread:** 90°

Installation and photometrics

Field lumens
7 000 lm

Efficacy
49 lm/W

Remote control

- **Data protocol:** USITT DMX512-A
RDM / Art-Net / sACN

- **Data IN connector:** 5 pins XLR mâle + etherCON RJ45
- **Data OUT connector:** 5 pins XLR femelle



• DMX chart:

Mode 1 (22 channels)

Dimmer @16b
8 colours @16b
Strobe: duration + speed
Response time
Control mode

Mode 2 (13 channels)

Dimmer @8b
8 colours @8b
Strobe: duration + speed
Response time
Control mode

Mode 3 (8 channels)

Dimmer @16b
Colour presets
CCT
Strobe: duration + speed
Response time
Control mode

Mode 4 (7 channels)

Dimmer @8b
Colour presets
CCT
Strobe: duration + speed
Response time
Control mode

Dimensions and weight

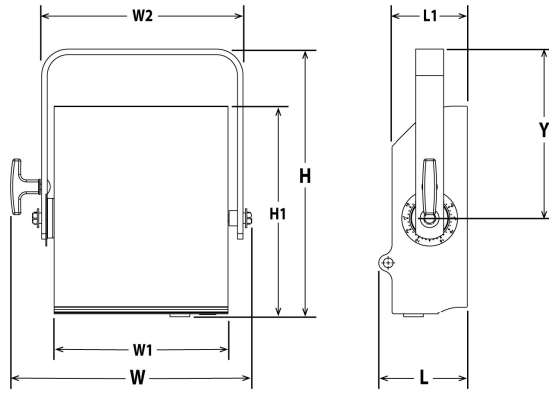

Weight: 6.5 kg (14.3 lbs)

| Height | Length | Width | Yoke | Tilt | Option |
|---|---|--|--------------------|---------|---------|
| H= 385 mm (15.2 in) H1= 303 mm (11.9 in) | L= 127 mm (5 in) L1= 108 mm (4.3 in) | W= 346 mm (13.6 in) W1= 250 mm (9.8 in) W2= 289 mm (11.4 in) | Y= 243 mm (9.6 in) | TD= 90° | TO= 90° |

Shipping

- **Weight :** 8.2 kg (18 lbs)
- **Volume :** .04 m³ (1.34 ft³)

Installation

- **Minimum distance to illuminated surface:** 0.2 m (0.7 ft)
- **Operating position:**

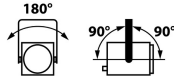

Construction

- **Housing:** Steel sheet - Aluminium
- **Colour:** Black
- **Cooling:** Convection cooling
- **Maximum ambient temperature (Ta):** 40°C (104°F)
- **Maximum case temperature (Tc):** 70°C (158°F)
- **Total heat dissipation:** 481 BTU/h
- **Protection rating:** 20

Electrical compatibility

- 220/230 V - 50 Hz
- 245 V - 50 Hz
- 110/120 V - 60 Hz
- 208 V - 60 Hz
- 220/230 V - 60 Hz
- 100 V - 50 Hz
- 100 V - 60 Hz
- Selector: automatic detection

Power input



- **Type:** Neutrik powerCON TRUE1 TOP (connector included)

Power consumption

| Voltage | Frequency | Current | Power | Power factor |
|---------|-----------|---------|-------|--------------|
| 230 V | 50 Hz | 0.8 A | 141 W | 0.72 |
| 120 V | 60 Hz | 1.3 A | 143 W | 0.91 |
| 100 V | 60 Hz | 1.5 A | 142 W | 0.92 |

Power Supply Unit

- **PSU:** Internal - Electronic PSU - Flicker free with PFC
- **Control:** Local / DMX
- **Protection:** -
- **Power thru:** Neutrik powerCON TRUE1 TOP - Maximum of 20 units (230 V) / 10 units (120 V)

Warranty

- **Fixture: 3 years**
See General Sales Condition on website

Approvals









Model

861

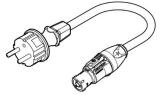
8 colours LED 150W Asymmetric washlight - 861 Dalis

Options

Accessories

| | | |
|--------------|---|---|
| CAL03 | 3 meter power cable (3G1,5 HO7RNF) with Neutrik PowerCon© True1 and CEE 7/7 (2P+T NF/SCHUKO) connectors |  |
| CAL05 | Combined Neutrik PowerCon© True1 / DMX (5 pins) patch cable - length: 1m |  |
| 872 | Doughty "Twenty clamp" with M10 screw/nut for Ø48 to 51mm pipes - SWL: 20Kg - TÜV approved - Poids: 0.25 Kg |  |
| 876 | Hook clamp 40x10mm with 28mm M10 screw for Ø35 to 50mm pipes - SWL: 50Kg - Poids: 1.25 Kg |  |
| 880 | Hook clamp 40x10mm with 28mm M10 screw for Ø50 to 63mm pipes - SWL: 50Kg - Poids: 1.36 Kg |  |
| CS2 | Safety cable Ø3 mm L= 600mm - SWL: 75 Kg |  |